

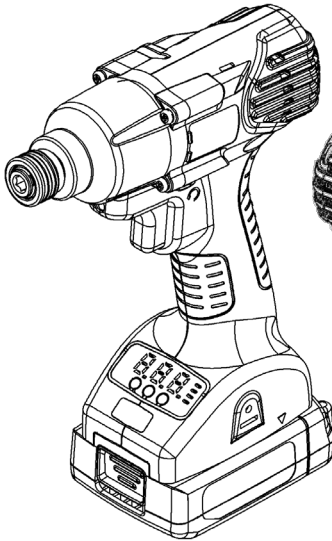

## PROGRAMMABLE CORDLESS IMPACT WRENCH OPERATION AND MAINTENANCE MANUAL

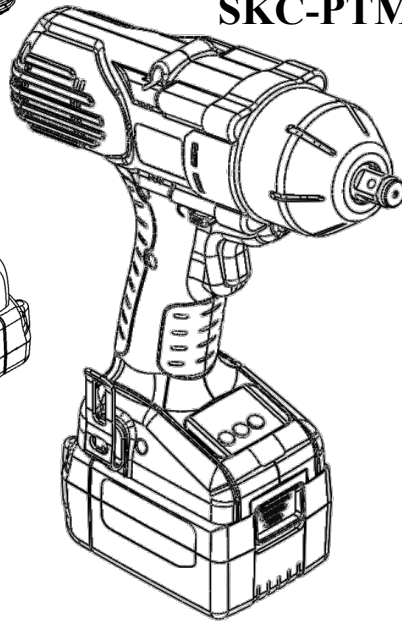

**SKC-PTM-50**  
**SKC-PTM-70**  
**SKC-PTM-100**



**SKC-PTM-200**

Rechargeable –TYPE: Impact Brushless Series

**KILEWS INDUSTRIAL CO., LTD.**

<http://www.kilews.com.tw>



Y2F211A-E-010







## Table of Contents





I.	<u>Symbol, Accessory Description</u> .....	2
II.	<u>Warning</u> .....	3
III.	<u>Protection Function, Warning, Operation Instructions</u> .....	4
IV.	<u>Screwdriver and Battery assembly/disassembly description</u> :.....	5
V.	<u>Brief Function Operating</u> .....	7
VI.	<u>Function Description</u> :.....	8
VII.	<u>Instructions</u> :.....	10
1.	<u>Main panel buttons and screen display instructions</u> :.....	10
2.	<u>KL-RC1 Remote control button icon description</u> :.....	10
3.	<u>Operation function setting description</u> :.....	13
4.	<u>Function Preset</u> : .....	16
5.	<u>Screwdriver, LED and BUZZER status description</u> . .....	16
IX.	<u>Other Instructions</u> .....	18
X.	<u>Main Technical Parameters</u> .....	19

**Please Read all Instructions Before Operation**  
(With parts exploded view)

**I. Symbol, Accessory Description**

**Symbol Description**

			
Please refer to the manual	Warning	Recyclable	Indoor use only

				
Keep away from moisture	Keep away from fire source	Do not take apart	Do not discard	Safety certification

**Accessories**

Product Name	Quantity	Unit
Manual	1	PC
Warranty certificate	1	PC
S belt hook	1	PC
Screw M3*0.5P*10LT	1	PC
BIT	2	PC
SOCKET ADAPTER & BIT WILL NOT BE PROVIDED WITH SQVARE HEAD TOOL		

## II. Warning

Before using the Battery Screwdriver, please check if the main parts/accessories are missing or broken and read thoroughly  the operating instructions carefully. Please follow the following precautions/operation instructions and basic safety measures to avoid fire, electric shock and personal injury etc.

1. Keep the workplace clean.
  - 1.1 Cluttered areas and workplaces are prone to injury.
  - 1.2 Do not operate or charge the chargeable tools in rain or water (humid environment). Avoid danger and short-circuit damage to the Battery Screwdriver.
2. Pay attention to the environment of the workplace.
  - 2.1 The Battery Screwdriver should be in a well-lighted workplace.
  - 2.2 Do not let others operate the Battery Screwdriver unless it is assigned. Keep children and people away to avoid danger.
  - 2.3 To ensure safety, do not playful while operating the Battery Screwdriver.
  - 2.4 Do not operate the Battery Screwdriver in a hazardous location (flammable gas or liquid).
  - 2.5 Do not operate the Battery Screwdriver when you are tired or taking alcohol or drugs to avoid danger.
3. When not using the Battery Screwdriver, remove the battery and store it in a dry and safe place.
4. To ensure the function and safety of the Battery Screwdriver, do not use it improperly.
5. Please carefully select the Battery Screwdriver of appropriate torque to do the operation according to the requirements of the parts to fasten in order to avoid danger and defects, do not use the Battery Screwdriver for unintended applications, such as: drilling, self-tapping screws, etc.
6. When using the Battery Screwdriver, dress properly. Do not wear loose clothing or jewelry, etc., to avoid danger from hooking by tools.
7. Hold the Battery Screwdriver properly before operation, then press the start button and avoid incorrect holding of the tool.
8. Use the Battery Screwdriver with S belt buckles, wrist straps, etc. to assist in work and storage, and keep them away from children, avoiding danger.
9. Careful maintenance tools and conduct regular inspection of the Battery Screwdriver and battery. In case of damage, use the designated repair center and keep the tool body clean, to avoid oil stains.
10. Unplug the power cord when the Battery station is not in use.
11. If you do not use the Battery Screwdriver for a long time, remove the rechargeable battery.
12. It is forbidden to use the parts and accessories (battery, Battery stand) of the Battery Screwdriver from others, for modification or reassembly, to avoid product defects and danger.
13. Stay alert when operating the Battery Screwdriver. Before using the Battery Screwdriver, carefully check the safety measures or if parts are broken to ensure that the tool can be used as intended.
14. Maintenance and Inspection: The screwdriver must be operated in top condition, one day working hour must be not more than eight hours. According to operating frequency and torque loaded, we suggest adding lubricating oils in clutch per year, and kindly contact with distributor when product's maintenance.
15. Please make sure to read and follow the precautions/operation instructions and basic safety measures in the manual. The company is not responsible for any danger caused by non-compliance.
16. Use a safety device: Wear protective earmuffs to reduce personal injury.

### Noise:

The typical A-weighted noise level acc. To EN62841-2-2

Sound pressure level(LpA): 53.6 dB(A)

Sound power level(LwA): 64.6 dB(A)

### Vibration:

The vibration total value acc. EN62841-2-2

Vibration emission value ah (m/s<sup>2</sup>): 0.17 m/s<sup>2</sup>

Uncertainty K (m/s<sup>2</sup>): 0.02 m/s<sup>2</sup>

17. Although the PTM-200 could reach torque up to 200 Nm. within five seconds, to avoid wearing components down and life cycle, a long time use at torque 180 Nm. or above does not recommend.
18. [Note] There will be 20% decreasing on torque when perform soft join.

### III. Protection Function, Warning, Operation Instructions

Over-current protection	Low battery protection
Temperature protection	Forward and reverse three-stage control protection
Low speed & stall protection	Sleep mode
Battery ID identification	

#### Protective Function for the Battery Screwdriver

#### Cautions

 **Do not disassemble or modify the Battery Screwdriver arbitrarily, otherwise, the warranty will not be Valid.**

1. Remove the battery before servicing the Battery Screwdriver. If you are not a qualified service technician, do not attempt to repair the Battery Screwdriver.
2. It is forbidden to disassemble or modify the Battery Screwdriver to avoid danger. If you install a battery from other company to cause product defects or related danger, our company is not responsible for repair and compensation.
3. Please be sure to use the original parts and lubricants to service the screwdriver. If using non-original parts for repair causes the Battery Screwdriver broken or related danger, the warranty will be void. Our company is not responsible for repair and compensation.
4. The most suitable working temperature is above 0°C and below ~35°C.

#### Operating Instructions

Before using this Battery Screwdriver, please fully charge the battery and then assemble it to assure safety. Before assemble/disassembly, please make sure that the forward/reverse switch lever is in the middle, as shown by the arrow below.

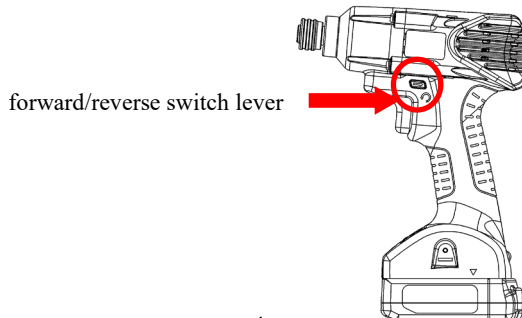

#### IV. The assembly/disassembly method for the Battery Screwdriver and Battery is shown in the figures below, with description:

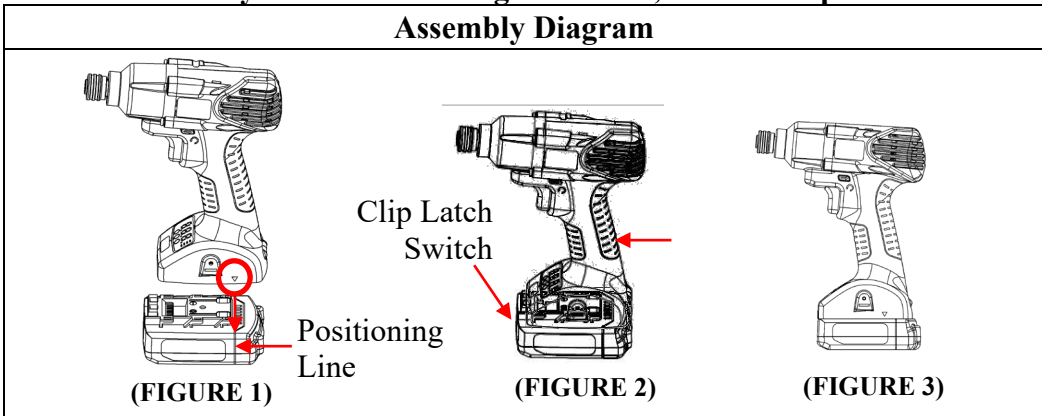

- (1) As shown by the circle in Figure 1: After the inverted triangle arrow on the screwdriver is aligned with the positioning line on the Battery, press the screwdriver down with clip latches.
- (2) Push the screwdriver as shown in Figure 2 in the direction of Battery clip latch, and you will hear a click, and the Battery clip latches will fasten the screwdriver.
- (3) Assembly is completed.

Awaken state	Press the trigger to wake up the screwdriver	Light	1. When the screwdriver and the Battery are not installed in the clip latches, the indicator light: flashing in red and green alternately. 2. The panel light is ON.	1. When the screwdriver and the Battery are installed by the clip latches, the indicator light: red or green light is ON~OFF. 2. The panel light is ON.
		Buzzer	When the screwdriver and the Battery are not installed in the clip latches, the buzzer sounds BB continuously.	When the screwdriver and the Battery are installed by the clip latches, the buzzer sounds BB once
		ID identification	If unsuccessful, the screwdriver disables to start running after pressing the trigger.	If successful, the screwdriver enables to start running after pressing the trigger.
Sleep state	after being awakened if ID identification is not performed within 7 seconds, it will go into sleep mode	Light	no	no
		Buzzer	no	no

## Disassembly Diagram

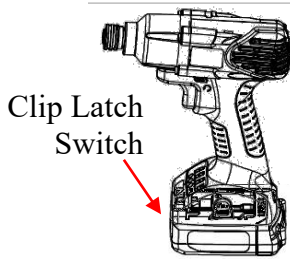

Clip Latch  
Switch

(FIGURE 1)

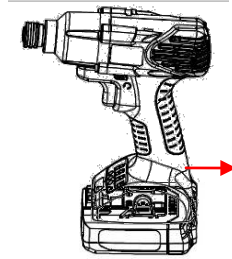

(FIGURE 2)

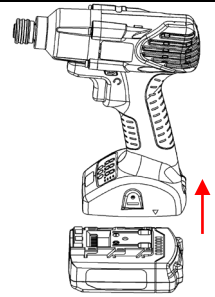

(FIGURE 3)

- (1) Press and hold the Battery clip latches.
- (2) Push the screwdriver all the way to the back.
- (3) Then take out the screwdriver and disassemble it.



## V. Brief Function Operating

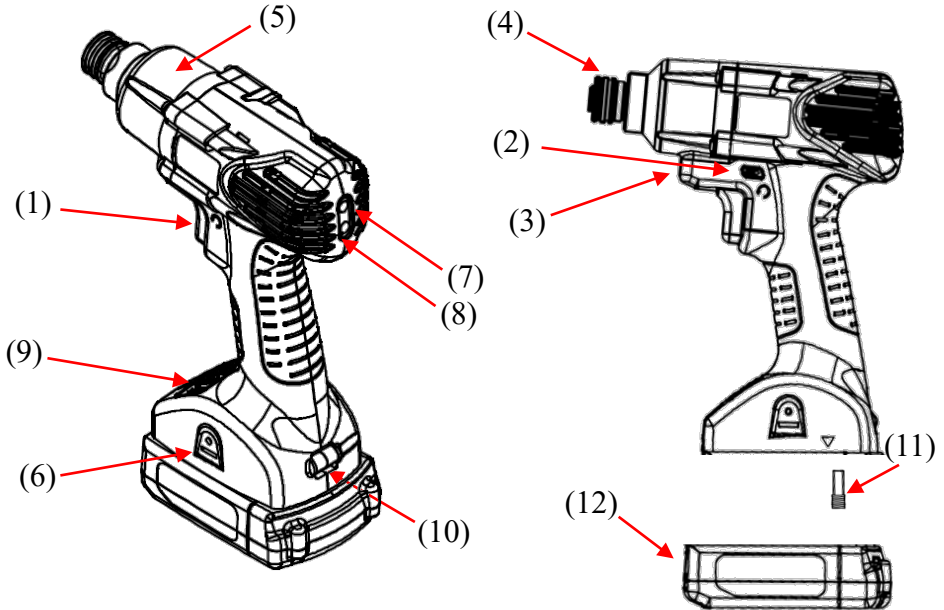

**Function Name Comparison Table**

Number	Name	Number	Name
(1)	Start trigger	(7)	Signal display light
(2)	Forward and reverse switch level	(8)	Power indicator light
(3)	LED lighting	(9)	Display panel
(4)	Bit sleeve	(10)	Wrist strap hole
(5)	Aluminum alloy front cover	(11)	Bluetooth
(6)	S belt hook hole	(12)	Rechargeable Battery

## VI. Function Description:

1. This Battery Screwdriver is an Impact Screwdriver. When the screw is being fastened with Da Da Da sound, it means the Battery Screwdriver continues to apply the impact until the stroke is completed, and then it will stop the impact action.

(1) Start trigger:

1-1. Press the start trigger 1/3 inward, and the Battery Screwdriver will start slowly. Press the trigger deeper, the screwdriver runs faster until the trigger is fully pressed, and full speed is reached. According to the setup condition, when the impact is stopped in the final position or the trigger is released, the Battery Screwdriver will stop running.

1-2. Press the trigger to wake up the screwdriver.

(2) Forward and reverse switch lever:

2-1. When pushing the forward and reverse switch lever to the right, follow the arrow symbol → on the switch for forward ↻, to tighten the screw; otherwise, follow the arrow symbol ← on the switch for reverse ↻, to loosen the screw, as shown in the figures below; whenever you do not use the Battery Screwdriver, leave the forward and reverse switch lever in the middle.

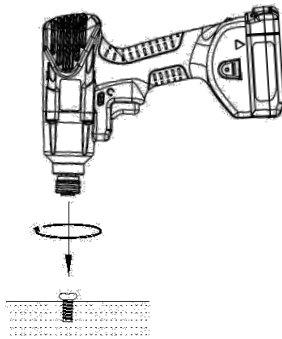

Forward  
(Lock Screw)

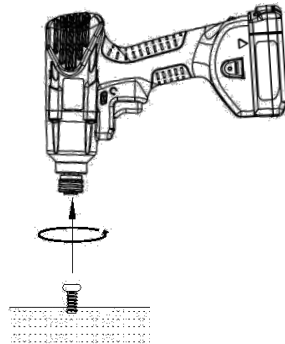

Reverse  
(Retract Screw)

2-2. Leave the forward and reverse switch lever in the middle, and press trigger to LED ON or OFF.

(3) LED light:

LED light is for auxiliary lighting, with option for on or off. Switch method: move the forward and reverse switch lever to the middle and press the trigger to turn on or off.

(4) Bit sleeve operation and compatibility:

Pull the cap of the Battery Screwdriver outward, and then load the BIT as shown in the following figures.

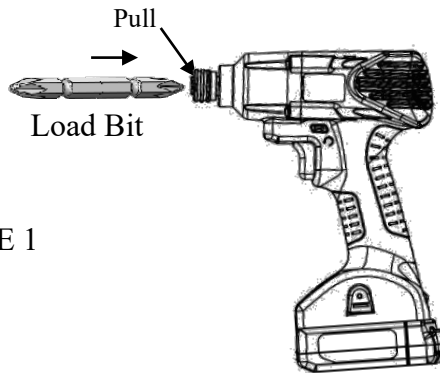

FIGURE 1

(5) Aluminum alloy front cover: Fix gear box.

(6) Screwdriver hook: Prevent falling during operation and facilitate hanging of the tool.

(7) S belt hook: It is convenient for the operator to hook up the Battery Screwdriver.

(8) & (9) Display light and buzzer: Refer to chapter V. screwdriver, LED and BUZZER status description.

(10) Display panel: Display settings and usage status.

(11) Wrist strap: The tool can be fixed to the wrist to prevent it from falling during operation, and it facilitates the storage of hanging tool.

(12) Bluetooth: For screwdriver to connect to controller wireless.



(13) Rechargeable Battery: For screwdriver.

2. Chemicals such as acetone, benzene, alcohol, thinner, ketones, trichloroethylene, etc. must not contact the case of the Battery Screwdriver to avoid chemical damage.

3. Please operate the Battery Screwdriver carefully in accordance with the operating instructions. Do not drop or subject the Battery Screwdriver to impact.
4. When the Battery Screwdriver is running, do not change the forward and reverse switch lever to avoid system error determination.
5. During the operation of the Battery Screwdriver, if the forward and reverse switch lever is changing, the Battery Screwdriver will start the protection program to stop the tool and will resume normal operation when it is restarted.
6. The mechanical wear of the Battery Screwdriver depends on the user's torque, time or frequency. The greater the torque, the longer the time or the higher the frequency, the faster the wear; after one month of use (8 hours every day, operating frequency 15Pcs/min) the minimum torque attenuation is about 2~3% of (the maximum is 3~5%), and the attenuation will gradually decrease and be stabilized over time. The user can periodically use the torque meter to determine if the torque output of the Battery Screwdriver meets the needs and timely compensate the attenuated torque.

## VII. Main panel and Remote control description:

### 1. Main panel buttons and screen display instructions:

 <p>The diagram shows the main panel of the battery screwdriver with four buttons: ST (with a left arrow and 'Hold' below), WS, Pc, and Res. A red box highlights the ST, WS, and Pc buttons.</p>	<p><b>Main panel button function description:</b></p> <ol style="list-style-type: none"> <li>1. WS/ST: Quickly browse the setting of the running Program/press and hold the button to enter the remote control setup mode.</li> <li>2. Pc: switch the running program  <b>*Remember that after the switch, press the “Res” button to return to the screwdriver work screen. Press the “Res” button again to reset counting.</b></li> <li>3. Res: Sleep wakeup/clear counter/confirm              When the screwdriver still for over 3 minutes, it will enter the sleep mode.</li> </ol>
 <p>The diagram shows the same main panel with a red box highlighting the three-digit LED display area.</p>	<p><b>Description of the panel display:</b></p> <ol style="list-style-type: none"> <li>1. The program is shown in the red frame on the left, with the range [1]~[5]</li> <li>2. The number of screws (batch count) is shown in the red frame in the middle, with the range [01]~[99]</li> <li>3. The battery status is on the right.</li> </ol>

## 2. KL-RC1 Remote control button icon description:

Press and hold on “WS” key button till “SE1” show up on screen.

(1)  after setup, illustration for remote controller buttons:

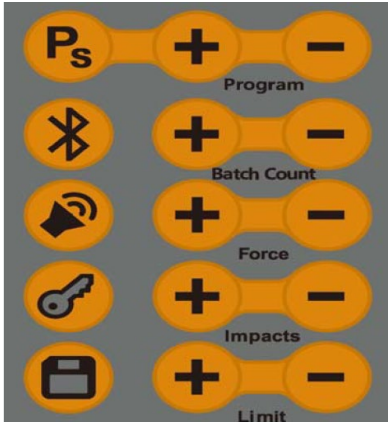
Program Select		Program
Bluetooth		Batch Count
Buzzer		Force
Lock		Impacts
Save		Limit

## 2. KL-RC1 Remote control button icon description:

Press and hold on “WS” key button till “SE1” show up then press “Pc” key button, and the “SE2” will show up on screen

(2)  after setup, illustration for remote controller buttons:

NG Confirm Function		Program
OK ALL Auto/Manual Function		Rundown Friction
N/A		Thread Preset Function
N/A		N/A
Save		N/A

## 2. KL-RC1 Remote control button icon description:

Press and hold “WS” and “Res” key buttons at the same time till “SE3” appears on screen.

(3)  after setup, illustration for remote controller buttons:

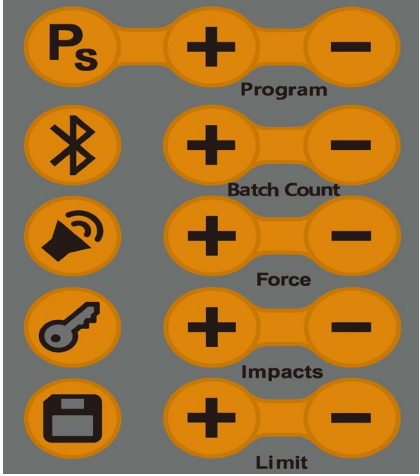
N/A		N/A
Firmware versions confirm & setting.		N/A
Tightening on forward/ reverse setting		N/A
Factory default setting		N/A
Save		N/A









### 3. Operation function setting description:

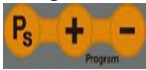





Step1 : Press and hold [WS/ST] button on the panel, to prompt [  SE1], then use the remote control to set up the parameters according to the function requirements.

Step2 : Press and hold the [number increase or decrease keys] on the remote control to speed up the value change.













Step3 : After setup, press [  Save] to return to the main screen.





※The screwdriver will save current setting automatically when operator null for over 30 seconds under setting mode.

Setup Items	Function Description	Factory Defaults
<p>Program</p> 	<p>Set Program: [P01~P05]:</p> <ol style="list-style-type: none"> <li>(1) In any Program, press [Select] to make or cancel a selection, which means selecting one or more Programs to run the workpiece.</li> <li>(2) If the workpiece content [P01] &amp; [P02]: When the screwdriver run to [P02], modify and save [P02] function, the program to start will not be [P01], but [P02], meaning program to run will be the one at exiting the setup mode.</li> <li>(3) Single program cycle setup: press the button and then press  to select the program, + and - to increase or decrease, after selecting  setting and operation, the fasten is only at P01 program setting until the last screw, and upon completion, it will automatically loop back to the P01 program selection operation (continuing for five single programs), and will not interact and cycle with other programs.</li> <li>(4) Multi-program cycle setup: press  button and then press to select the program, call the single program  and press the  button again to select.  By using + and - to increase or decrease, multi-program selection is available for cycle operation, for example, select P.0.1 and P.0.2 programs, when the last screw fasten of the P.0.1 program is completed, it automatically cycles to P.0.2 program to run the operation and so on.</li> </ol>	<p>P01</p>
<p>Bluetooth</p> 	<p>Bluetooth function: bLn ON and bLF OFF.</p>	<p>bLF</p>

<p>Buzzer</p> 	<p>Buzzer sound function: bun ON [Warning tone], buF OFF [Warning tone] status.</p>	<p>Bun</p>
<p>Lock</p> 	<p>[program switch button] Lock function:          (1) Lcn [Lock]: The program cannot be switched.          (2) LcF [Unlock]: The program can be switched.</p>	<p>LcF</p>
<p>Save</p> 	<p>Save function:          (1) After the setup is completed, save and exit the setup function, and the main panel screen displays the work screen.          (2) After the setup is completed, it will not run for 30 seconds and will be saved automatically; and the main panel screen displays the work screen.          (3) After the main screen display returns to the work screen, press the "Res" button to update the batch count to the new setting.          (4) After storage is completed, the main panel screen returns to the work screen and shows the last stored program selection.</p>	<p>*</p>
<p>Botch Count</p> 	<p>Batch Count setting for screw fasten:          (1) The setting value is [noF] [n01]~[n99], set according to the number of screws to fasten.          (2) [noF] is to turn off the screw count display.</p>	<p>n05</p>
<p>Force</p> 	<p>Impact Force setting: Adjust the impact force based on needs setting value is [F01]~[F03]</p>	<p>F01</p>
<p>Impacts</p> 	<p>Impact Setting:          The PTM-200&amp;PTM-100&amp;PTM-70 is the level of impact setting from [H01] to [H99]. Adjust impact level slightly to reach target torque.          The PTM-50 is the level of impact setting from [H01] to [H50].          Adjust impact level slightly to reach target torque.          [HoF] is to turn off the parameter display. (Start the pressure plate let go, the screwdriver stop tap)</p>	<p>H10</p>
<p>Limit</p> 	<p>Limit rotation number setup:          The setting value is [LoF] [L02]~[L99], and the Limit rotation number is adjusted based on needs.          [LoF] is to turn off Limit count display.</p>	<p>LoF</p>



<p>Display Panel</p>  <p>+</p> <p>Batch Count</p> 	<p>Ignore Rundown Friction:</p> <ol style="list-style-type: none"> <li>1. Press and hold “WS” button on the counter panel until “SE1” shows up on the screen.</li> <li>2. Press “Pc” button to prompt “SE2” on the screen, and use “Batch Count” on the remote controller for setting.</li> <li>3. The [uoF] is the level of thread setting from [u01] to [u99]. Adjust forcing threads for your tightening needs. (Ensured threads)</li> <li>4. The [uoF] setting may cause “L” setting invalid when [uoF] thread value is equal or greater than “L”.</li> </ol>	<p>uoF</p>
<p>Display Panel</p>  <p>+</p> <p>Force</p> 	<p>Thread Preset Setting:</p> <ol style="list-style-type: none"> <li>1. Press and hold “WS” key button till “SE1” shows up.</li> <li>2. Press “Pc” key button till “SE2” shows up and then setup “Force” from remote control.</li> <li>3. The [coF] is the level of thread setting from [c01] to [c99].</li> <li>4. Adjust preset threads for your tightening needs. The screwdriver will auto shut off and appear OK when tightening has reached preset value.</li> </ol>	<p>coF</p>
<p>Display Panel</p>  <p>+</p> 	<p>NG Confirm Setting:</p> <ol style="list-style-type: none"> <li>1. Press and hold “WS” button on the counter panel until “SE1” shows up on the screen.</li> <li>2. Press “Pc” button to prompt “SE2” on the screen and use the “  ” on the remote controller for setting.</li> <li>3. The [ncF] &amp; [ncn] perform when NG shows up, system locks or unlocks screwdriver.</li> <li>4. The [ncF] is disable and the [ncn] is enable. The screwdriver will go to the status of NG confirm when the value of impact setting is less than the value of “L” setting.</li> <li>5. To unlock screwdriver by releasing trigger and press “Res” button when signs of a red LED keep on and buzzer keeps on briefly.</li> </ol>	<p>ncF</p>
<p>Display Panel</p>  <p>+</p> 	<p>OK ALL Auto/Manual Settings:</p> <ol style="list-style-type: none"> <li>1. Press and hold “WS” button on the counter panel until “SE1” shows up on the screen.</li> <li>2. Press “Pc” button to prompt “SE2” on the screen, and use “  ” on the remote controller for setting.</li> <li>3. The setting value is [AcF] [Acn], to set function based on needs.</li> <li>4. When set to [Acn], the screwdriver rotation behavior will be prohibited when OK ALL occurred, then need to press the "Res" button to confirm and functional resume.</li> </ol>	<p>AcF</p>
<p>Display Panel</p>  <p>+</p> 	<p>Forward Fastened/Reverse Fastened Setting:</p> <ol style="list-style-type: none"> <li>1. Press and hold “WS+Res” button until “SE3” shows up on the screen.</li> <li>2. Use “  ” on the remote controller for setting.</li> <li>3. The setting value is [rrF] [rrn], to set function based on needs.</li> </ol>	<p>rrF</p>

<p>Display Panel</p> 	<p>Reset to Default Settings:</p> <ol style="list-style-type: none"> <li>1. Press “WS+Res” button on the counter panel until “SE3” shows up on the screen.</li> <li>2. Your setting will be completed when  shows numbers of program set/ screw and hear a “Beep” sound by press “Key ” button from remote control</li> <li>3. Press “Res” button again to return to standby mode.</li> </ol>	
<p>Display Panel</p> 	<p>Version Confirmation Setting:</p> <ol style="list-style-type: none"> <li>1. Press and hold “WS+Res” button on the counter panel until “SE3” shows up on the screen.</li> <li>2. Press “” button on the remote controller, and the screen will display the version in full bright light. Press “Save”, after hearing “beep” sound, completion is confirmed.</li> </ol>	

Remark: Press and hold +/- button to increase the adjustment speed of the relevant parameters [01]~[99].

Program	P01	P02	P03	P04	P05
Batch Count	n05	n05	n05	n05	n05
Force	F01	F01	F01	F01	F01
Impacts	H10	H10	H10	H10	H10
Limit	LoF	LoF	LoF	LoF	LoF

#### 4. Values of Function Preset

Other preset values like bLF, bun.....rrF

※“LoF” preset is OFF.

※Other function presets are:

Bluetooth: bLF, Buzzer: bun, Lock: LcF, Thread disregard setting: uoF, OK All Auto/ Manual setting: AcF, NG confirm setting: ncF, Clockwise/ Counterclockwise: rrF

#### 5. Screwdriver, LED and BUZZER status description:

Function Name	Screwdriver Status	LED Status	Buzzer warning tone (bun ON)
OK	Fasten is completed and the screwdriver is stopped	Green light is ON (up)	1 short tone
OK ALL	Fastening entire workpiece is completed and the screwdriver is released	Green light, red light (up)	1 long tone
NOK	Fasten operation error	Red light is ON (up)	Keep a short tone until the trigger is released

The Limit rotation number is abnormal		During fasten operation, the screwdriver completes the fastening faster than the set Limit, and NOK phenomenon occurs.	Red light is ON (up)	Keep a rapid short tone until the trigger is released
Stripped Screw		During fasten operation, the screwdriver continues fasten, and fastening cannot be completed.	Red light is ON (up)	Keep a short tone until the trigger is released
Sleep mode		1. When the screwdriver does not run for over 180Sec, it will enter the sleep mode 2. The parameter is set to disable sleep mode	no	no
Overcurrent protection (A)		In the protection state, red LED on with 2 short beep sounds. The tool will restore normal after 10 seconds with 1 short beep sound.	Red LED on. (Top side)	2 consecutive short tones
Thermal Protector (°C)		Motor cannot start when temperature exceed 80 °C be start when temperature below 70 °C	Motor temperature protection : Red LED flashes MOS temperature protection : Orange LED flashes	no
Low speed & stall protection:		In the protection state, red LED on with 3 short beep sound. The tool will restore normal after 10 seconds with 1 short beep sound.	Red LED on. (Top side)	3 consecutive short tones
Battery ID identification is abnormal		The screwdriver does not work	Red/green light flashes alternately	Continuous Beep sound
Low voltage	Less than 14.0V	Function normal	Red light is ON (down)	N/A
Insufficient voltage	Less than 13.8V	Unable to start	Red light flashes (down)	Keep a short tone until the battery is removed

**CAUTION!!**

When low battery red light flashes, screwdriver cannot reach to its maximum torque setting. Please change battery pack or charge it.

## IX. Other Instructions:

1. The optimal use of this Battery Screwdriver is no more than 8 hours per day.
2. The repair and maintenance of the Battery Screwdriver can be sent to the designated after-sales service center or the local service center via the original dealer. If the product is disassembled by the customer, our company will not be responsible for repairs.
3. If the customer sends the Battery Screwdriver to a service center that is not designated by our company for repair or self-disassembly, the resulting quality issue will not be covered by the warranty.
4. It is the responsibility of the management department of the Battery Screwdriver to assure this manual be provided and read by the operators or users . Do not attempt to repair the Battery Screwdriver by yourself.
5. To remove the protective cover, please remove the slots on both sides as shown in the following figure. To install the protective cover, have the protective cover notch downward and push the Battery Screwdriver into it, and assure it is stuck in slots, as shown in the following figure.

FIGURE 1



FIGURE 2



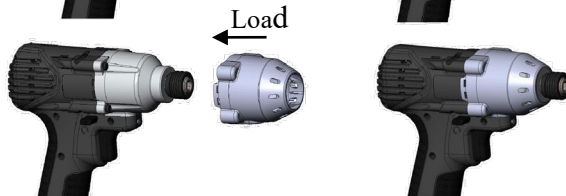



6. Please use our company's specified testing equipment and screws to test PTM Impact Screwdriver.
7. This screwdriver is of clutch type mechanical control and the test conditions is based ISO 6789.

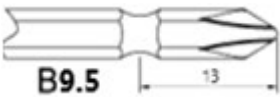

### Description of Compatibility of Battery and Battery Station

1. Please use our company's specified Battery and consult with the agent to introduce according to the customer needs.
2. Our Battery Screwdriver and Battery built-in ID Identification Function Protection, it cannot be activated if using non-original Battery or Battery Screwdriver.

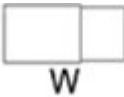
## X. Main Technical Parameters:

<b>Model (SKC-)</b>	PTM-100			PTM-70				PTM-50				
<b>Input Voltage (DC)</b>	DC 14.4V			DC 14.4V				DC14.4V				
<b>Rotating Speed (r.p.m)</b>	0~2000			0~2600				0~1900				
<b>Blows per minute (B.P.M)</b>	0~2600			0~3400				0~2500				
<b>Torque (N.m)</b>	20~100			20~70				8~50				
<b>Torque accuracy (%)</b>	Set PTM-100&PTM-70 at 80% output using M16 bolt ,KTM-IWT400 tester measured PTM-100&PTM-70 torque accuracy is $\pm 8\sim 10\%$ Set PTM-50 at 80% output using M12 bolt ,KTM-IWT400 tester measured PTM-50 torque accuracy is $\pm 8\sim 10\%$											
<b>Torque Tester</b>	KTM-IWT50 apply for testing M6 、 M8 、 M10 bolts KTM-IWT400 apply for testing M10 、 M12 、 M14 、 M16 bolts											
<b>Bolt size</b>	M10	M12	M14	M16	M8	M10	M12	M14	M6	M8	M10	M12
	8   40	20   70	20   90	28   100	8   30	8   40	20   60	20   70	3   20	3   20	5   30	12   50
<b>Impact Force</b>	1-3			1-3				1-3				
<b>Weight (Kg)</b>	1.02kg (w/o battery)			1kg (w/o battery)				0.98kg (w/o battery)				
<b>Operating hours</b>	1.0s ON 3.0s OFF											
<b>Length (mm)</b>	174mm * 202mm (L * H w/o battery )											
<b>Suitable for rechargeable batteries</b>	SKC-LB1430											
<b>Applicable Battery station</b>	SKC-P70W											
<b>Applicable remote control</b>	KL-RC1											
<b>Applicable screwdriver head</b>	B9.5 、 W3/8 、 W1/2			B9.5 、 W3/8				B9.5 、 W3/8				
												

Screwdriver head code: W: Square head B: Hex 6.35mm Hexagon screwdriver.

SKC-PTM-50B 、 SKC-PTM-70B with BIT 3# 2 Pcs

SOCKETS DO NOT COME WITH ANY SQUARE HEAD SKC-PTM-100 SERIES

## Main Technical Parameters:

<b>Model (SKC-)</b>	PTM-200			
<b>Input Voltage (DC)</b>	DC 14.4V			
<b>Rotating Speed (r.p.m)</b>	0~1700			
<b>Blows per minute (B.P.M)</b>	0~2100			
<b>Torque (N.m)</b>	25~180/(Max:200)			
<b>Torque accuracy (%)</b>	Set PTM-200 at 80% output using M20 bolt, KTM-IWT400 tester measured PTM-200 torque accuracy is $\pm 8\sim 10\%$			
<b>Torque Tester</b>	KTM-IWT400 apply for testing M12、M14、M16、M20 bolts			
<b>Bolt size</b>	M12	M14	M16	M20
	15	22	22	23
	 110	 120	 140	 200
<b>Impact Force</b>	1-3			
<b>Weight (Kg)</b>	1.5kg (w/o battery)			
<b>Operating hours</b>	1.0s ON 3.0s OFF			
<b>Length (mm)</b>	219.4mm * 220.2mm (L * H w/o battery )			
<b>Suitable for rechargeable batteries</b>	SKC-LB1430			
<b>Applicable Battery station</b>	SKC-P70W			
<b>Applicable remote control</b>	KL-RC1			
<b>Applicable screwdriver head</b>	W1/2			
				

Screwdriver head code: W: Square head

SOCKETS DO NOT COME WITH ANY SQUARE HEAD SKC-PTM-200 SERIES

**Caution**   
**Please save this manual properly**

**Our company reserves the right to  
 modify the product without prior**